



DWG:	1000-HS20
DATE:	August 12, 2021
SCALE:	NTS

CDA Redi Mix and Precast
6399 W. Bedrock Rd.
Post Falls, ID 83854
(208)762-0235

1,000 Gallon HS-20 Traffic Rated Septic Tank

MANUFACTURED IN ACCORDANCE WITH ASTM C-913

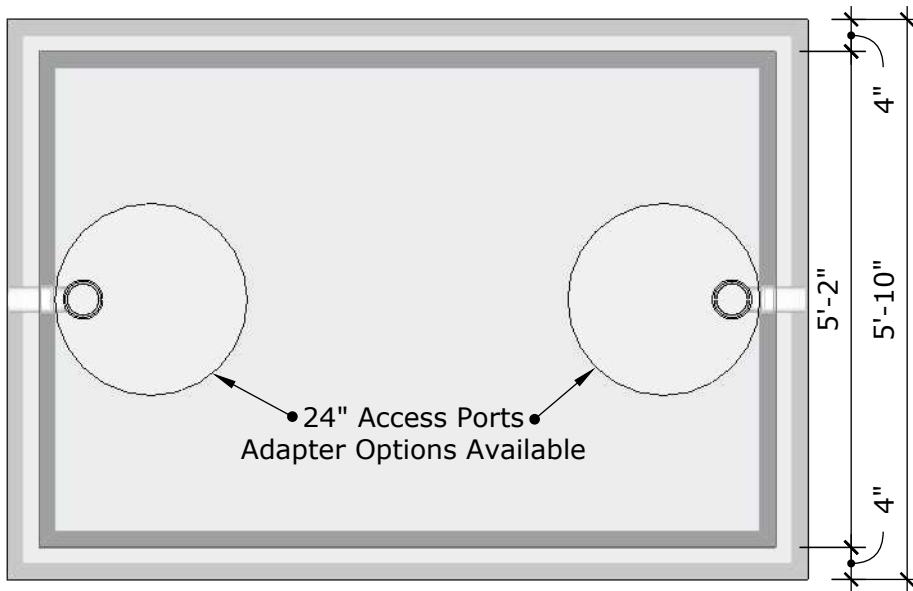

TOP

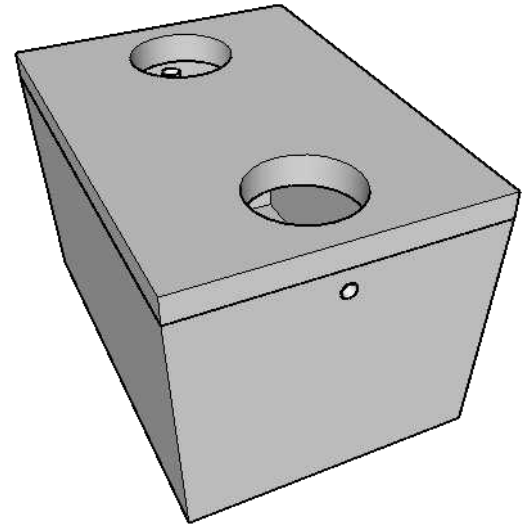

ITEM	WEIGHT
LID	3374#
TANK	7524#

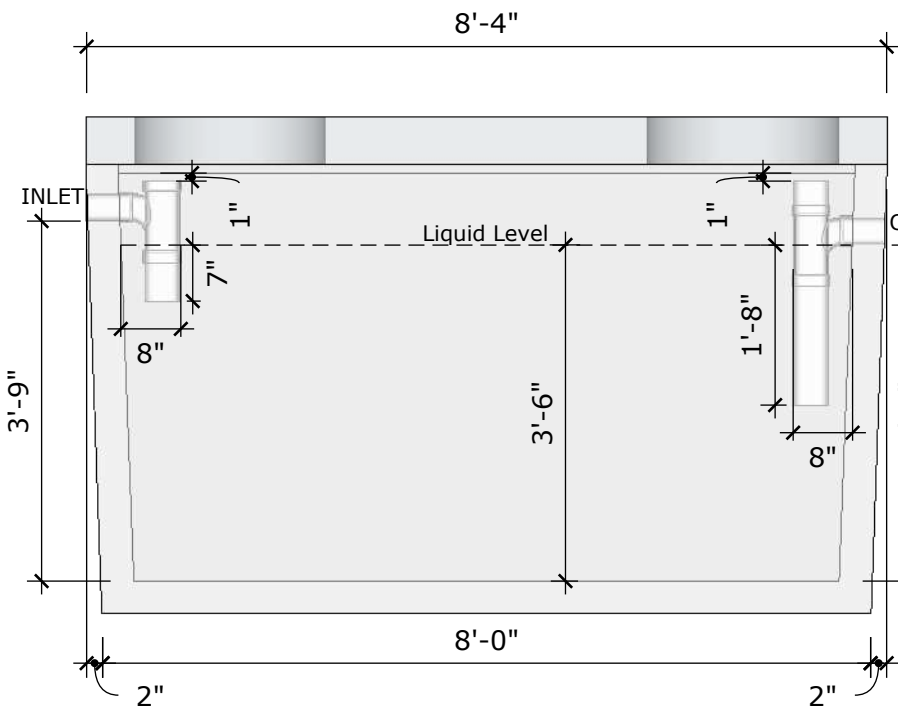

FRONT

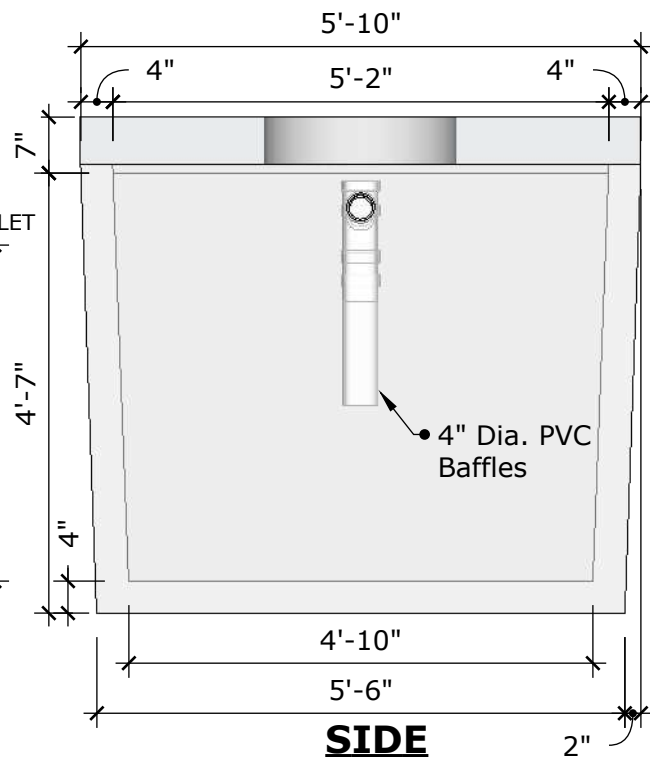

SIDE

NOTE: Tank rated for 6' of maximum bury with HS-20 traffic rating.
 Available with 5" thick non-traffic lid.